

Technical Documentation

RF0/72C
Rolled Steel TEFC | AEGHPE

Date: July 10, 2017

Dimensional Drawing

Catalogue	Model	HP	Pole	kW	Rating	Voltage	Hz	RPM
RF0/72C	AEGHPE	0.75	2	0.56	Continuous	230 / 460 V	60	3600

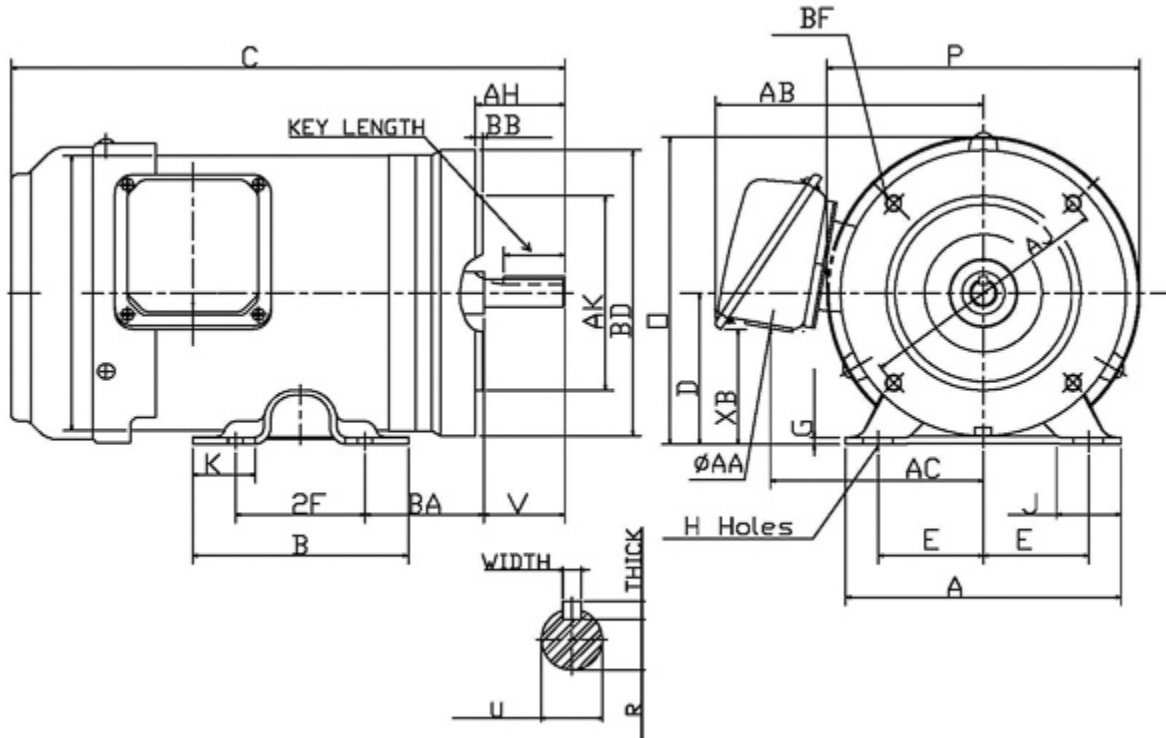

Frame Size	Mounting					A	B	C	CD	D	
	E	2F	2F2	H	BA						
56C	2.44	3		0.34x0.68	2.75	6.38	3.94	10.58		3.5	
G	J	K	L	M	O	P	T	Key			Keyseat
								Width	Thick	Length	R
0.16	1.54				6.81	6.61		0.188	0.188	1.41	0.517
Terminal Housing				Aux Box		C/D Flange					
AA	AB	AC	XB	AE	AX	BB	AH	AK	BD	Aj	BF
1.1	5.87	4.64	2.61			0.16	2.06	4.5	6.61	5.875	3/8-16
Shaft Extension			Bearings		Approx. Weight Lbs	SPL dBA/3ft	Ins. Class	S.F.	Drive Method	Dimensions	
N-W	U	V	DE	NDE							
1.875	0.625	1.88	6204ZZ	6203ZZ	23	59	F	1.15	Direct Coupling / Belt Drive	Inches	

Technical Data Sheet

Motor Type: AEGHPE

Catalogue No: RF0/72C

Nameplate Information

HP	Pole	RPM	Frame	Voltage	Hz	Phase
0.75	2	3425	56C	230 / 460	60	3
Enclosure	Ins. Class	Service Factor	Time Rating	NEMA Design	Rated Amb.	Rated Altitude
TEFC	F	1.15	Continuous	B	-40 to 40°C °C	<3300 ft

Typical Performance

Efficiency (%)				Power Factor (%)		
Full Load		3/4 Load	1/2 Load	Full Load	3/4 Load	1/2 Load
Nom.	Min.					
76.8	73.4	76.5	71.5	80.0	72.0	60.0
Torque				Current (A)		
Full Load (lb-ft)	Locked Rotor (% FLT)	Pull Up (% FLT)	Break Down (% FLT)	No Load	Full Load	Locked Rotor
1.13	330	290	445	1.4 / 0.7	2.3 / 1.2	16 / 8
NEMA KVA Code	Inertia (WR ²)			Safe Stall Time (s)		Noise Level Sound Press. dB(A)
	Rotor (lb-ft ²)	NEMA Load (lb-ft ²)	Max. Allowable (lb-ft ²)	Cold	Hot	
K	0.025	1.5	10.19	45	31	59

VFD Duty Information

Speed Range			VFD		S.F.
Constant Torque	Variable Torque	Constant Power	Carrier	Type	
6-60Hz	3-60Hz	60-120Hz	≤ 5 kHz	VPWM or CPWM	1.0 Only

Additional Information

Bearings		Approx. Weight
DE	NDE	lbs
6204ZZ	6203ZZ	23

Hazardous Locations Information

N/A	
0	
0	
Temp Code (Sinewave / VFD)	0 / 0

Nameplate Drawing

Rolled Steel TEFC

TYPE	AEGHPE	CAT. NO.	RF0/72C		
OUTPUT	0.75 HP 0.56 kW	FRAME	56C	TEFC	
R.P.M.	3425	POLE	2	INS.	F
VOLTS	230 / 460	PHASE	3	Hz	60
AMPS	2.3 / 1.2	CODE	K	S.F.	1.15
AMBIENT	40 °C	NOM. EFF. 76.8		MIN. EFF. 73.4	
BEARINGS	6204ZZ / 6203ZZ			RATING Cont.	
SER. NO.	TBD	DESIGN	B	WT. 23 LBS	
PWM VFD DUTY	VT	CT	CP	S.F.	
	3-60Hz	6-60Hz	60-120Hz	1.0 Only	

Connection Diagram

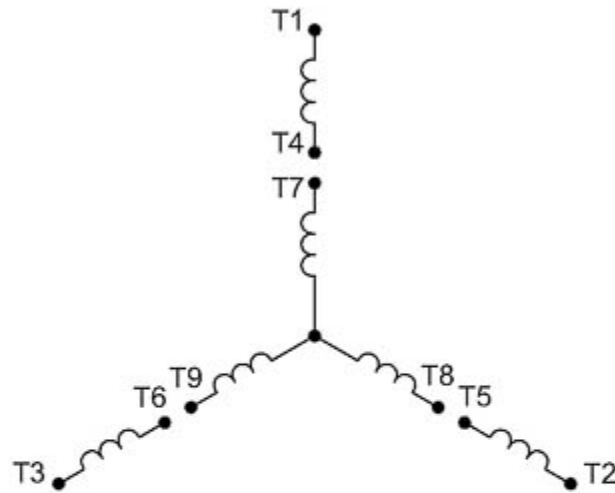

9 LEAD DUAL VOLTAGE WYE					
VOLTAGE	CONN.	L1	L2	L3	JOIN
HIGH	WYE	1	2	3	4&7,5&8,6&9
LOW	2 WYE	1,7	2,8	3,9	4&5&6

WD_9Y